

## 8. Circular saws

---



+7 812 335 59 35  
[info@suntools.ru](mailto:info@suntools.ru)







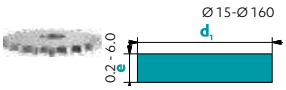

# Index - Slitting saws & circular cutters

<b>8. Circular saws</b>		<b>page</b>
		<b>211</b>
<b>223</b>	Slitting saw DIN 1838 coarse pitch	215
<b>223-1</b>	Slitting saw DIN 1837 fine pitch	221
<b>223-2</b>	Slitting saw extra fine pitch	227
<b>225</b>	Slitting saw spiral toothing	232
<b>226</b>	Slitting saw staggered teeth	234
<b>227</b>	Slitting saw - staggered teeth - 3 cuts	236
<b>228</b>	Angle cutter 60° - 2 cuts	238
<b>228-1</b>	Angle cutter 45° - 2 cuts	239
<b>228-2</b>	Angle cutter 12° to 20°	240
<b>228-3</b>	Angle cutter 30° - 1 cut	241
<b>228-4</b>	Angle cutter 45° - 1 cut	242
<b>228-5</b>	Angle cutter 60° - 1 cut	243
<b>229-1</b>	Bioconical cutter 60°	244
<b>229-2</b>	Bioconical cutter 90°	245
<b>229-3</b>	Bioconical cutter 120°	246
<b>232</b>	Radius cutter convex	247
<b>234</b>	Radius cutter concave	250

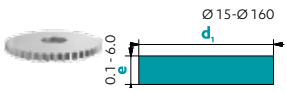

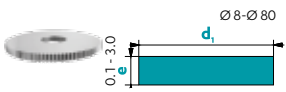

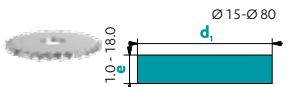
# Slitting saws & circular cutters

## Table of Contents



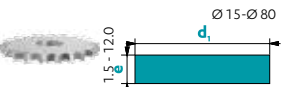

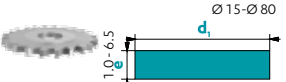

### Saws and mills

<b>REF. 223</b>			<b>Z</b> 20-80	<b>λ</b> 0°	<b>Page</b> 215
<b>REF. 223-1</b>			<b>Z</b> 24-160	<b>λ</b> 0°	<b>Page</b> 221
<b>REF. 223-2</b>			<b>Z</b> 48-160	<b>λ</b> 0°	<b>Page</b> 227
<b>REF. 225</b>			<b>Z</b> 48-160	<b>λ</b> 20°	<b>Page</b> 232

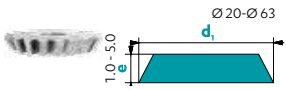

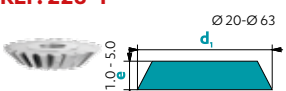

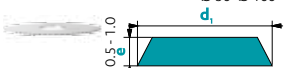

### Slitting saws with staggered teeth

<b>REF. 226</b>			<b>Z</b> 12-36	<b>λ</b> ALT	<b>Page</b> 234
<b>REF. 227</b>			<b>Z</b> 12-36	<b>λ</b> ALT	<b>Page</b> 236

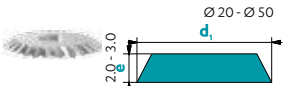

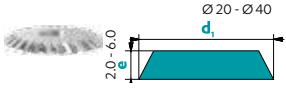

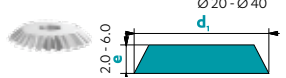

### Angular cutters - 2 cuts

<b>REF. 228</b>			<b>Z</b> 20-40	<b>λ</b> 0°	<b>Page</b> 238
<b>REF. 228-1</b>			<b>Z</b> 20-40	<b>λ</b> 0°	<b>Page</b> 239
<b>REF. 228-2</b>			<b>Z</b> 20-40	<b>λ</b> 0°	<b>Page</b> 240

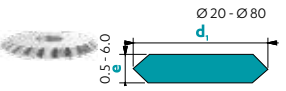

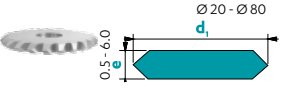

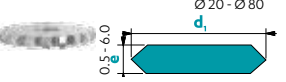
### Angular cutters - 1 cuts

<b>REF. 228-3</b>			<b>Z</b> 20-50	<b>λ</b> 0°	<b>Page</b> 241
<b>REF. 228-4</b>			<b>Z</b> 20-50	<b>λ</b> 0°	<b>Page</b> 242
<b>REF. 228-5</b>			<b>Z</b> 20-50	<b>λ</b> 0°	<b>Page</b> 243

### Biconical cutters

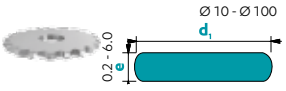
<b>REF. 229-1</b>			<b>Z</b> 20-48	<b>λ</b> 0°	<b>Page</b> 244
<b>REF. 229-2</b>			<b>Z</b> 20-48	<b>λ</b> 0°	<b>Page</b> 245
<b>REF. 229-3</b>			<b>Z</b> 20-48	<b>λ</b> 0°	<b>Page</b> 246

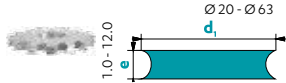
### Radius cutters

<b>REF. 232</b>			<b>Z</b> 8-60	<b>λ</b> 0°	<b>Page</b> 247
<b>REF. 234</b>			<b>Z</b> 8-26	<b>λ</b> 0°	<b>Page</b> 250



# Slitting saw DIN 1838 coarse pitch

223

Material	Vc uncoated	Vc coated	Uncoated	Coated	Rec. Coating
Steel < 700 N/mm <sup>2</sup>	80	120	☐	■	Trio
Steel > 700 N/mm <sup>2</sup>	60	100	☐	■	Trio
Stainless steel	60	100	☐	■	Trio
Cast iron	50	90	☐	■	Nemo
Copper	200	300	☐	■	Solo
Brass - Bronze	200	300	■	☐	Solo
Aluminium	250	400	☐	■	Solo
Gold - Silver	150	300	☐	■	Solo
Platinum - Palladium	-	-	-	-	-
Superalloys	20	40	☐	■	Trio
Titanium	40	60	■	■	Rico

not adapted - adapted ☐ highly adapted ■

Tolerance e: +/-0.01  
d<sub>2</sub>: H5

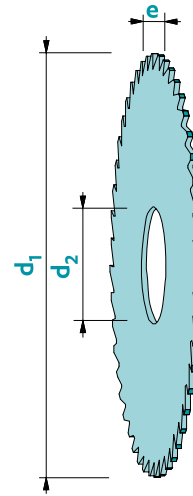

Available uncoated or coated (see page 61)

Art. n°	d <sub>1</sub>	e	d <sub>2</sub>	Z
223d15e0.20a5Z20	15	0.20	5	20
223d15e0.25a5Z20	15	0.25	5	20
223d15e0.30a5Z20	15	0.30	5	20
223d15e0.35a5Z20	15	0.35	5	20
223d15e0.40a5Z20	15	0.40	5	20
223d15e0.45a5Z20	15	0.45	5	20
223d15e0.50a5Z20	15	0.50	5	20
223d15e0.60a5Z20	15	0.60	5	20
223d15e0.70a5Z20	15	0.70	5	20
223d15e0.80a5Z20	15	0.80	5	20
223d15e0.90a5Z20	15	0.90	5	20
223d15e1.00a5Z20	15	1.00	5	20
223d15e1.10a5Z20	15	1.10	5	20
223d15e1.20a5Z20	15	1.20	5	20
223d15e1.30a5Z20	15	1.30	5	20
223d15e1.40a5Z20	15	1.40	5	20
223d15e1.50a5Z20	15	1.50	5	20
223d15e1.60a5Z20	15	1.60	5	20
223d15e1.70a5Z20	15	1.70	5	20
223d15e1.80a5Z20	15	1.80	5	20
223d15e1.90a5Z20	15	1.90	5	20
223d15e2.00a5Z20	15	2.00	5	20
223d15e2.10a5Z20	15	2.10	5	20
223d15e2.20a5Z20	15	2.20	5	20
223d15e2.30a5Z20	15	2.30	5	20
223d15e2.40a5Z20	15	2.40	5	20
223d15e2.50a5Z20	15	2.50	5	20
223d15e2.60a5Z20	15	2.60	5	20
223d15e2.70a5Z20	15	2.70	5	20
223d15e2.80a5Z20	15	2.80	5	20

Art. n°	d <sub>1</sub>	e	d <sub>2</sub>	Z
223d15e2.90a5Z20	15	2.90	5	20
223d15e3.00a5Z20	15	3.00	5	20
223d15e3.10a5Z20	15	3.10	5	20
223d15e3.20a5Z20	15	3.20	5	20
223d15e3.30a5Z20	15	3.30	5	20
223d15e3.40a5Z20	15	3.40	5	20
223d15e3.50a5Z20	15	3.50	5	20
223d15e3.60a5Z20	15	3.60	5	20
223d15e3.70a5Z20	15	3.70	5	20
223d15e3.80a5Z20	15	3.80	5	20
223d15e3.90a5Z20	15	3.90	5	20
223d15e4.00a5Z20	15	4.00	5	20
223d15e4.50a5Z20	15	4.50	5	20
223d15e5.00a5Z20	15	5.00	5	20
223d15e5.50a5Z20	15	5.50	5	20
223d15e6.00a5Z20	15	6.00	5	20
223d20e0.20a5Z20	20	0.20	5	20
223d20e0.25a5Z20	20	0.25	5	20
223d20e0.30a5Z20	20	0.30	5	20
223d20e0.35a5Z20	20	0.35	5	20
223d20e0.40a5Z20	20	0.40	5	20
223d20e0.45a5Z20	20	0.45	5	20
223d20e0.50a5Z20	20	0.50	5	20
223d20e0.60a5Z20	20	0.60	5	20
223d20e0.70a5Z20	20	0.70	5	20
223d20e0.80a5Z20	20	0.80	5	20
223d20e0.90a5Z20	20	0.90	5	20
223d20e1.00a5Z20	20	1.00	5	20
223d20e1.10a5Z20	20	1.10	5	20
223d20e1.20a5Z20	20	1.20	5	20



Z  
20-80



λ  
0°

γ  
8°

MG6

N

## Slitting saw DIN 1838 coarse pitch



Available uncoated or coated (see page 61)



**Z**  
20-80

**λ**  
0°

**γ**  
8°

**MG6**

**N**

Art. n°	d <sub>1</sub>	e	d <sub>2</sub>	Z
223d20e1.30a5Z20	20	1.30	5	20
223d20e1.40a5Z20	20	1.40	5	20
223d20e1.50a5Z20	20	1.50	5	20
223d20e1.60a5Z20	20	1.60	5	20
223d20e1.70a5Z20	20	1.70	5	20
223d20e1.80a5Z20	20	1.80	5	20
223d20e1.90a5Z20	20	1.90	5	20
223d20e2.00a5Z20	20	2.00	5	20
223d20e2.10a5Z20	20	2.10	5	20
223d20e2.20a5Z20	20	2.20	5	20
223d20e2.30a5Z20	20	2.30	5	20
223d20e2.40a5Z20	20	2.40	5	20
223d20e2.50a5Z20	20	2.50	5	20
223d20e2.60a5Z20	20	2.60	5	20
223d20e2.70a5Z20	20	2.70	5	20
223d20e2.80a5Z20	20	2.80	5	20
223d20e2.90a5Z20	20	2.90	5	20
223d20e3.00a5Z20	20	3.00	5	20
223d20e3.10a5Z20	20	3.10	5	20
223d20e3.20a5Z20	20	3.20	5	20
223d20e3.30a5Z20	20	3.30	5	20
223d20e3.40a5Z20	20	3.40	5	20
223d20e3.50a5Z20	20	3.50	5	20
223d20e3.60a5Z20	20	3.60	5	20
223d20e3.70a5Z20	20	3.70	5	20
223d20e3.80a5Z20	20	3.80	5	20
223d20e3.90a5Z20	20	3.90	5	20
223d20e4.00a5Z20	20	4.00	5	20
223d20e4.50a5Z20	20	4.50	5	20
223d20e5.00a5Z20	20	5.00	5	20
223d20e5.50a5Z20	20	5.50	5	20
223d20e6.00a5Z20	20	6.00	5	20
223d25e0.20a8Z20	25	0.20	8	20
223d25e0.25a8Z20	25	0.25	8	20
223d25e0.30a8Z20	25	0.30	8	20
223d25e0.35a8Z20	25	0.35	8	20
223d25e0.40a8Z20	25	0.40	8	20
223d25e0.45a8Z20	25	0.45	8	20
223d25e0.50a8Z20	25	0.50	8	20
223d25e0.60a8Z20	25	0.60	8	20
223d25e0.70a8Z20	25	0.70	8	20
223d25e0.80a8Z20	25	0.80	8	20
223d25e0.90a8Z20	25	0.90	8	20
223d25e1.00a8Z20	25	1.00	8	20
223d25e1.10a8Z20	25	1.10	8	20

Art. n°	d <sub>1</sub>	e	d <sub>2</sub>	Z
223d25e1.20a8Z20	25	1.20	8	20
223d25e1.30a8Z20	25	1.30	8	20
223d25e1.40a8Z20	25	1.40	8	20
223d25e1.50a8Z20	25	1.50	8	20
223d25e1.60a8Z20	25	1.60	8	20
223d25e1.70a8Z20	25	1.70	8	20
223d25e1.80a8Z20	25	1.80	8	20
223d25e1.90a8Z20	25	1.90	8	20
223d25e2.00a8Z20	25	2.00	8	20
223d25e2.10a8Z20	25	2.10	8	20
223d25e2.20a8Z20	25	2.20	8	20
223d25e2.30a8Z20	25	2.30	8	20
223d25e2.40a8Z20	25	2.40	8	20
223d25e2.50a8Z20	25	2.50	8	20
223d25e2.60a8Z20	25	2.60	8	20
223d25e2.70a8Z20	25	2.70	8	20
223d25e2.80a8Z20	25	2.80	8	20
223d25e2.90a8Z20	25	2.90	8	20
223d25e3.00a8Z20	25	3.00	8	20
223d25e3.10a8Z20	25	3.10	8	20
223d25e3.20a8Z20	25	3.20	8	20
223d25e3.30a8Z20	25	3.30	8	20
223d25e3.40a8Z20	25	3.40	8	20
223d25e3.50a8Z20	25	3.50	8	20
223d25e3.60a8Z20	25	3.60	8	20
223d25e3.70a8Z20	25	3.70	8	20
223d25e3.80a8Z20	25	3.80	8	20
223d25e3.90a8Z20	25	3.90	8	20
223d25e4.00a8Z20	25	4.00	8	20
223d25e4.50a8Z20	25	4.50	8	20
223d25e5.00a8Z20	25	5.00	8	20
223d25e5.50a8Z20	25	5.50	8	20
223d25e6.00a8Z20	25	6.00	8	20
223d30e0.20a8Z30	30	0.20	8	30
223d30e0.25a8Z30	30	0.25	8	30
223d30e0.30a8Z30	30	0.30	8	30
223d30e0.35a8Z30	30	0.35	8	30
223d30e0.40a8Z30	30	0.40	8	30
223d30e0.45a8Z30	30	0.45	8	30
223d30e0.50a8Z30	30	0.50	8	30
223d30e0.60a8Z30	30	0.60	8	30
223d30e0.70a8Z30	30	0.70	8	30
223d30e0.80a8Z24	30	0.80	8	24
223d30e0.90a8Z24	30	0.90	8	24
223d30e1.00a8Z24	30	1.00	8	24



# Slitting saw DIN 1838 coarse pitch

223

Continuation

Art. n°	d <sub>1</sub>	e	d <sub>2</sub>	Z	Art. n°	d <sub>1</sub>	e	d <sub>2</sub>	Z
223d30e1.10a8Z24	30	1.10	8	24	223d40e1.00a10Z32	40	1.00	10	32
223d30e1.20a8Z24	30	1.20	8	24	223d40e1.10a10Z32	40	1.10	10	32
223d30e1.30a8Z24	30	1.30	8	24	223d40e1.20a10Z32	40	1.20	10	32
223d30e1.40a8Z24	30	1.40	8	24	223d40e1.30a10Z32	40	1.30	10	32
223d30e1.50a8Z24	30	1.50	8	24	223d40e1.40a10Z32	40	1.40	10	32
223d30e1.60a8Z24	30	1.60	8	24	223d40e1.50a10Z32	40	1.50	10	32
223d30e1.70a8Z24	30	1.70	8	24	223d40e1.60a10Z32	40	1.60	10	32
223d30e1.80a8Z24	30	1.80	8	24	223d40e1.70a10Z24	40	1.70	10	24
223d30e1.90a8Z24	30	1.90	8	24	223d40e1.80a10Z24	40	1.80	10	24
223d30e2.00a8Z24	30	2.00	8	24	223d40e1.90a10Z24	40	1.90	10	24
223d30e2.10a8Z24	30	2.10	8	24	223d40e2.00a10Z24	40	2.00	10	24
223d30e2.20a8Z24	30	2.20	8	24	223d40e2.10a10Z24	40	2.10	10	24
223d30e2.30a8Z24	30	2.30	8	24	223d40e2.20a10Z24	40	2.20	10	24
223d30e2.40a8Z24	30	2.40	8	24	223d40e2.30a10Z24	40	2.30	10	24
223d30e2.50a8Z24	30	2.50	8	24	223d40e2.40a10Z24	40	2.40	10	24
223d30e2.60a8Z24	30	2.60	8	24	223d40e2.50a10Z24	40	2.50	10	24
223d30e2.70a8Z24	30	2.70	8	24	223d40e2.60a10Z24	40	2.60	10	24
223d30e2.80a8Z24	30	2.80	8	24	223d40e2.70a10Z24	40	2.70	10	24
223d30e2.90a8Z24	30	2.90	8	24	223d40e2.80a10Z24	40	2.80	10	24
223d30e3.00a8Z24	30	3.00	8	24	223d40e2.90a10Z24	40	2.90	10	24
223d30e3.10a8Z24	30	3.10	8	24	223d40e3.00a10Z24	40	3.00	10	24
223d30e3.20a8Z24	30	3.20	8	24	223d40e3.10a10Z20	40	3.10	10	20
223d30e3.30a8Z24	30	3.30	8	24	223d40e3.20a10Z20	40	3.20	10	20
223d30e3.40a8Z24	30	3.40	8	24	223d40e3.30a10Z20	40	3.30	10	20
223d30e3.50a8Z24	30	3.50	8	24	223d40e3.40a10Z20	40	3.40	10	20
223d30e3.60a8Z24	30	3.60	8	24	223d40e3.50a10Z20	40	3.50	10	20
223d30e3.70a8Z24	30	3.70	8	24	223d40e3.60a10Z20	40	3.60	10	20
223d30e3.80a8Z24	30	3.80	8	24	223d40e3.70a10Z20	40	3.70	10	20
223d30e3.90a8Z24	30	3.90	8	24	223d40e3.80a10Z20	40	3.80	10	20
223d30e4.00a8Z24	30	4.00	8	24	223d40e3.90a10Z20	40	3.90	10	20
223d30e4.50a8Z24	30	4.50	8	24	223d40e4.00a10Z20	40	4.00	10	20
223d30e5.00a8Z24	30	5.00	8	24	223d40e4.50a10Z20	40	4.50	10	20
223d30e5.50a8Z24	30	5.50	8	24	223d40e5.00a10Z20	40	5.00	10	20
223d30e6.00a8Z24	30	6.00	8	24	223d40e5.50a10Z20	40	5.50	10	20
223d40e0.20a10Z40	40	0.20	10	40	223d40e6.00a10Z20	40	6.00	10	20
223d40e0.25a10Z40	40	0.25	10	40	223d50e0.40a13Z48	50	0.40	13	48
223d40e0.30a10Z40	40	0.30	10	40	223d50e0.45a13Z48	50	0.45	13	48
223d40e0.35a10Z40	40	0.35	10	40	223d50e0.50a13Z48	50	0.50	13	48
223d40e0.40a10Z40	40	0.40	10	40	223d50e0.60a13Z40	50	0.60	13	40
223d40e0.45a10Z40	40	0.45	10	40	223d50e0.70a13Z40	50	0.70	13	40
223d40e0.50a10Z40	40	0.50	10	40	223d50e0.80a13Z40	50	0.80	13	40
223d40e0.60a10Z40	40	0.60	10	40	223d50e0.90a13Z40	50	0.90	13	40
223d40e0.70a10Z40	40	0.70	10	40	223d50e1.00a13Z40	50	1.00	13	40
223d40e0.80a10Z32	40	0.80	10	32	223d50e1.10a13Z40	50	1.10	13	40
223d40e0.90a10Z32	40	0.90	10	32	223d50e1.20a13Z40	50	1.20	13	40



Available uncoated or coated (see page 61)



Z  
20-80



λ  
0°

γ  
8°

MG6

N

## Slitting saw DIN 1838 coarse pitch



Available  
uncoated or coated  
(see page 61)

**Z**  
20-80

**λ**  
0° **γ**  
8°

**MG6** **N**

Art. n°	d <sub>1</sub>	e	d <sub>2</sub>	Z
223d50e1.30a13Z32	50	1.30	13	32
223d50e1.40a13Z32	50	1.40	13	32
223d50e1.50a13Z32	50	1.50	13	32
223d50e1.60a13Z32	50	1.60	13	32
223d50e1.70a13Z32	50	1.70	13	32
223d50e1.80a13Z32	50	1.80	13	32
223d50e1.90a13Z32	50	1.90	13	32
223d50e2.00a13Z32	50	2.00	13	32
223d50e2.10a13Z32	50	2.10	13	32
223d50e2.20a13Z32	50	2.20	13	32
223d50e2.30a13Z32	50	2.30	13	32
223d50e2.40a13Z32	50	2.40	13	32
223d50e2.50a13Z32	50	2.50	13	32
223d50e2.60a13Z24	50	2.60	13	24
223d50e2.70a13Z24	50	2.70	13	24
223d50e2.80a13Z24	50	2.80	13	24
223d50e2.90a13Z24	50	2.90	13	24
223d50e3.00a13Z24	50	3.00	13	24
223d50e3.10a13Z24	50	3.10	13	24
223d50e3.20a13Z24	50	3.20	13	24
223d50e3.30a13Z24	50	3.30	13	24
223d50e3.40a13Z24	50	3.40	13	24
223d50e3.50a13Z24	50	3.50	13	24
223d50e3.60a13Z24	50	3.60	13	24
223d50e3.70a13Z24	50	3.70	13	24
223d50e3.80a13Z24	50	3.80	13	24
223d50e3.90a13Z24	50	3.90	13	24
223d50e4.00a13Z24	50	4.00	13	24
223d50e4.50a13Z24	50	4.50	13	24
223d50e5.00a13Z24	50	5.00	13	24
223d50e5.50a13Z20	50	5.50	13	20
223d50e6.00a13Z20	50	6.00	13	20
223d63e0.40a16Z64	63	0.40	16	64
223d63e0.45a16Z64	63	0.45	16	64
223d63e0.50a16Z64	63	0.50	16	64
223d63e0.60a16Z48	63	0.60	16	48
223d63e0.70a16Z48	63	0.70	16	48
223d63e0.80a16Z48	63	0.80	16	48
223d63e0.90a16Z48	63	0.90	16	48
223d63e1.00a16Z40	63	1.00	16	40
223d63e1.10a16Z40	63	1.10	16	40
223d63e1.20a16Z40	63	1.20	16	40
223d63e1.30a16Z40	63	1.30	16	40
223d63e1.40a16Z40	63	1.40	16	40
223d63e1.50a16Z40	63	1.50	16	40

Art. n°	d <sub>1</sub>	e	d <sub>2</sub>	Z
223d63e1.60a16Z40	63	1.60	16	40
223d63e1.70a16Z40	63	1.70	16	40
223d63e1.80a16Z40	63	1.80	16	40
223d63e1.90a16Z40	63	1.90	16	40
223d63e2.00a16Z40	63	2.00	16	40
223d63e2.10a16Z32	63	2.10	16	32
223d63e2.20a16Z32	63	2.20	16	32
223d63e2.30a16Z32	63	2.30	16	32
223d63e2.40a16Z32	63	2.40	16	32
223d63e2.50a16Z32	63	2.50	16	32
223d63e2.60a16Z32	63	2.60	16	32
223d63e2.70a16Z32	63	2.70	16	32
223d63e2.80a16Z32	63	2.80	16	32
223d63e2.90a16Z32	63	2.90	16	32
223d63e3.00a16Z32	63	3.00	16	32
223d63e3.10a16Z32	63	3.10	16	32
223d63e3.20a16Z32	63	3.20	16	32
223d63e3.30a16Z32	63	3.30	16	32
223d63e3.40a16Z32	63	3.40	16	32
223d63e3.50a16Z32	63	3.50	16	32
223d63e3.60a16Z32	63	3.60	16	32
223d63e3.70a16Z32	63	3.70	16	32
223d63e3.80a16Z32	63	3.80	16	32
223d63e3.90a16Z32	63	3.90	16	32
223d63e4.00a16Z32	63	4.00	16	32
223d63e4.50a16Z24	63	4.50	16	24
223d63e5.00a16Z24	63	5.00	16	24
223d63e5.50a16Z24	63	5.50	16	24
223d63e6.00a16Z24	63	6.00	16	24
223d80e0.60a22Z64	80	0.60	22	64
223d80e0.70a22Z64	80	0.70	22	64
223d80e0.80a22Z64	80	0.80	22	64
223d80e0.90a22Z48	80	0.90	22	48
223d80e1.00a22Z48	80	1.00	22	48
223d80e1.10a22Z48	80	1.10	22	48
223d80e1.20a22Z48	80	1.20	22	48
223d80e1.30a22Z48	80	1.30	22	48
223d80e1.40a22Z48	80	1.40	22	48
223d80e1.50a22Z48	80	1.50	22	48
223d80e1.60a22Z48	80	1.60	22	48
223d80e1.70a22Z40	80	1.70	22	40
223d80e1.80a22Z40	80	1.80	22	40
223d80e1.90a22Z40	80	1.90	22	40
223d80e2.00a22Z40	80	2.00	22	40
223d80e2.10a22Z40	80	2.10	22	40



# Slitting saw DIN 1838 coarse pitch

223

Continuation

Art. n°	d <sub>1</sub>	e	d <sub>2</sub>	Z	Art. n°	d <sub>1</sub>	e	d <sub>2</sub>	Z
223d80e2.20a22Z40	80	2.20	22	40	223d100e2.80a22Z40	100	2.80	22	40
223d80e2.30a22Z40	80	2.30	22	40	223d100e2.90a22Z40	100	2.90	22	40
223d80e2.40a22Z40	80	2.40	22	40	223d100e3.00a22Z40	100	3.00	22	40
223d80e2.50a22Z40	80	2.50	22	40	223d100e3.10a22Z40	100	3.10	22	40
223d80e2.60a22Z40	80	2.60	22	40	223d100e3.20a22Z40	100	3.20	22	40
223d80e2.70a22Z40	80	2.70	22	40	223d100e3.30a22Z40	100	3.30	22	40
223d80e2.80a22Z40	80	2.80	22	40	223d100e3.40a22Z40	100	3.40	22	40
223d80e2.90a22Z40	80	2.90	22	40	223d100e3.50a22Z40	100	3.50	22	40
223d80e3.00a22Z40	80	3.00	22	40	223d100e3.60a22Z40	100	3.60	22	40
223d80e3.10a22Z32	80	3.10	22	32	223d100e3.70a22Z40	100	3.70	22	40
223d80e3.20a22Z32	80	3.20	22	32	223d100e3.80a22Z40	100	3.80	22	40
223d80e3.30a22Z32	80	3.30	22	32	223d100e3.90a22Z40	100	3.90	22	40
223d80e3.40a22Z32	80	3.40	22	32	223d100e4.00a22Z40	100	4.00	22	40
223d80e3.50a22Z32	80	3.50	22	32	223d100e4.50a22Z40	100	4.50	22	40
223d80e3.60a22Z32	80	3.60	22	32	223d100e5.00a22Z40	100	5.00	22	40
223d80e3.70a22Z32	80	3.70	22	32	223d100e5.50a22Z32	100	5.50	22	32
223d80e3.80a22Z32	80	3.80	22	32	223d100e6.00a22Z32	100	6.00	22	32
223d80e3.90a22Z32	80	3.90	22	32	223d125e0.80a22Z80	125	0.80	22	80
223d80e4.00a22Z32	80	4.00	22	32	223d125e0.90a22Z80	125	0.90	22	80
223d80e4.50a22Z32	80	4.50	22	32	223d125e1.00a22Z80	125	1.00	22	80
223d80e5.00a22Z32	80	5.00	22	32	223d125e1.10a22Z64	125	1.10	22	64
223d80e5.50a22Z32	80	5.50	22	32	223d125e1.20a22Z64	125	1.20	22	64
223d80e6.00a22Z32	80	6.00	22	32	223d125e1.30a22Z64	125	1.30	22	64
223d100e0.60a22Z80	100	0.60	22	80	223d125e1.40a22Z64	125	1.40	22	64
223d100e0.70a22Z64	100	0.70	22	64	223d125e1.50a22Z64	125	1.50	22	64
223d100e0.80a22Z64	100	0.80	22	64	223d125e1.60a22Z64	125	1.60	22	64
223d100e0.90a22Z64	100	0.90	22	64	223d125e1.70a22Z64	125	1.70	22	64
223d100e1.00a22Z64	100	1.00	22	64	223d125e1.80a22Z64	125	1.80	22	64
223d100e1.10a22Z64	100	1.10	22	64	223d125e1.90a22Z64	125	1.90	22	64
223d100e1.20a22Z64	100	1.20	22	64	223d125e2.00a22Z64	125	2.00	22	64
223d100e1.30a22Z48	100	1.30	22	48	223d125e2.10a22Z48	125	2.10	22	48
223d100e1.40a22Z48	100	1.40	22	48	223d125e2.20a22Z48	125	2.20	22	48
223d100e1.50a22Z48	100	1.50	22	48	223d125e2.30a22Z48	125	2.30	22	48
223d100e1.60a22Z48	100	1.60	22	48	223d125e2.40a22Z48	125	2.40	22	48
223d100e1.70a22Z48	100	1.70	22	48	223d125e2.50a22Z48	125	2.50	22	48
223d100e1.80a22Z48	100	1.80	22	48	223d125e2.60a22Z48	125	2.60	22	48
223d100e1.90a22Z48	100	1.90	22	48	223d125e2.70a22Z48	125	2.70	22	48
223d100e2.00a22Z48	100	2.00	22	48	223d125e2.80a22Z48	125	2.80	22	48
223d100e2.10a22Z48	100	2.10	22	48	223d125e2.90a22Z48	125	2.90	22	48
223d100e2.20a22Z48	100	2.20	22	48	223d125e3.00a22Z48	125	3.00	22	48
223d100e2.30a22Z48	100	2.30	22	48	223d125e3.10a22Z48	125	3.10	22	48
223d100e2.40a22Z48	100	2.40	22	48	223d125e3.20a22Z48	125	3.20	22	48
223d100e2.50a22Z48	100	2.50	22	48	223d125e3.30a22Z48	125	3.30	22	48
223d100e2.60a22Z40	100	2.60	22	40	223d125e3.40a22Z48	125	3.40	22	48
223d100e2.70a22Z40	100	2.70	22	40	223d125e3.50a22Z48	125	3.50	22	48



Available uncoated or coated (see page 61)



Z  
20-80



λ  
0°

γ  
8°

MG6

N

## Slitting saw DIN 1838 coarse pitch



Available  
uncoated or coated  
(see page 61)



**Z**  
20-80



**$\lambda$**   
0°

**$\gamma$**   
8°

**MG6**

**N**

Art. n°	$d_1$	e	$d_2$	Z
223d125e3.60a22Z48	125	3.60	22	48
223d125e3.70a22Z48	125	3.70	22	48
223d125e3.80a22Z48	125	3.80	22	48
223d125e3.90a22Z48	125	3.90	22	48
223d125e4.00a22Z48	125	4.00	22	48
223d125e4.50a22Z40	125	4.50	22	40
223d125e5.00a22Z40	125	5.00	22	40
223d125e5.50a22Z40	125	5.50	22	40
223d125e6.00a22Z40	125	6.00	22	40
223d160e1.00a32Z80	160	1.00	32	80
223d160e1.20a32Z80	160	1.20	32	80
223d160e1.50a32Z80	160	1.50	32	80
223d160e2.00a32Z80	160	2.00	32	80
223d160e2.50a32Z80	160	2.50	32	80
223d160e3.00a32Z64	160	3.00	32	64

## Slitting saw DIN 1837 fine pitch

Material	Vc uncoated	Vc coated	Uncoated	Coated	Rec. Coating
Steel < 700 N/mm <sup>2</sup>	80	120	□	■	Trio
Steel > 700 N/mm <sup>2</sup>	60	100	□	■	Trio
Stainless steel	60	100	□	■	Trio
Cast iron	50	90	□	■	Nemo
Copper	200	300	□	■	Solo
Brass - Bronze	200	300	□	■	Solo
Aluminium	250	400	□	■	Solo
Gold - Silver	150	300	■	-	Solo
Platinum - Palladium	-	-	-	-	-
Superalloys	20	40	□	■	Trio
Titanium	40	60	□	■	Rico

not adapted - adapted □ highly adapted ■

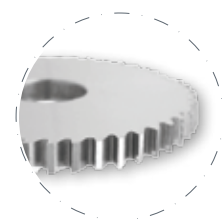
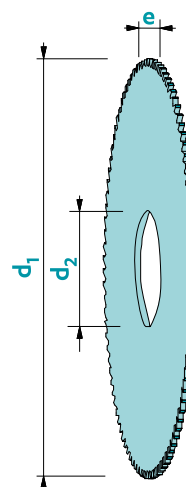



Available uncoated or coated (see page 61)

Tolerance e: +/-0.01  
d<sub>2</sub>: H5

Art. n°	d <sub>1</sub>	e	d <sub>2</sub>	Z	Art. n°	d <sub>1</sub>	e	d <sub>2</sub>	Z
223-1d15e0.10A5Z64	15	0.10	5	64	223-1d15e2.70A5Z40	15	2.70	5	40
223-1d15e0.15A5Z64	15	0.15	5	64	223-1d15e2.80A5Z40	15	2.80	5	40
223-1d15e0.20A5Z64	15	0.20	5	64	223-1d15e2.90A5Z40	15	2.90	5	40
223-1d15e0.25A5Z64	15	0.25	5	64	223-1d15e3.00A5Z40	15	3.00	5	40
223-1d15e0.30A5Z64	15	0.30	5	64	223-1d15e3.10A5Z24	15	3.10	5	24
223-1d15e0.35A5Z64	15	0.35	5	64	223-1d15e3.20A5Z24	15	3.20	5	24
223-1d15e0.40A5Z64	15	0.40	5	64	223-1d15e3.30A5Z24	15	3.30	5	24
223-1d15e0.45A5Z48	15	0.45	5	48	223-1d15e3.40A5Z24	15	3.40	5	24
223-1d15e0.50A5Z48	15	0.50	5	48	223-1d15e3.50A5Z24	15	3.50	5	24
223-1d15e0.60A5Z48	15	0.60	5	48	223-1d15e3.60A5Z24	15	3.60	5	24
223-1d15e0.70A5Z48	15	0.70	5	48	223-1d15e3.70A5Z24	15	3.70	5	24
223-1d15e0.80A5Z40	15	0.80	5	40	223-1d15e3.80A5Z24	15	3.80	5	24
223-1d15e0.90A5Z40	15	0.90	5	40	223-1d15e3.90A5Z24	15	3.90	5	24
223-1d15e1.00A5Z40	15	1.00	5	40	223-1d15e4.00A5Z24	15	4.00	5	24
223-1d15e1.10A5Z40	15	1.10	5	40	223-1d15e4.50A5Z24	15	4.50	5	24
223-1d15e1.20A5Z40	15	1.20	5	40	223-1d15e5.00A5Z24	15	5.00	5	24
223-1d15e1.30A5Z40	15	1.30	5	40	223-1d15e5.50A5Z24	15	5.50	5	24
223-1d15e1.40A5Z40	15	1.40	5	40	223-1d15e6.00A5Z24	15	6.00	5	24
223-1d15e1.50A5Z40	15	1.50	5	40	223-1d20e0.10A5Z80	20	0.10	5	80
223-1d15e1.60A5Z40	15	1.60	5	40	223-1d20e0.15A5Z80	20	0.15	5	80
223-1d15e1.70A5Z40	15	1.70	5	40	223-1d20e0.20A5Z80	20	0.20	5	80
223-1d15e1.80A5Z40	15	1.80	5	40	223-1d20e0.25A5Z64	20	0.25	5	64
223-1d15e1.90A5Z40	15	1.90	5	40	223-1d20e0.30A5Z64	20	0.30	5	64
223-1d15e2.00A5Z40	15	2.00	5	40	223-1d20e0.35A5Z64	20	0.35	5	64
223-1d15e2.10A5Z40	15	2.10	5	40	223-1d20e0.40A5Z64	20	0.40	5	64
223-1d15e2.20A5Z40	15	2.20	5	40	223-1d20e0.45A5Z48	20	0.45	5	48
223-1d15e2.30A5Z40	15	2.30	5	40	223-1d20e0.50A5Z48	20	0.50	5	48
223-1d15e2.40A5Z40	15	2.40	5	40	223-1d20e0.60A5Z48	20	0.60	5	48
223-1d15e2.50A5Z40	15	2.50	5	40	223-1d20e0.70A5Z48	20	0.70	5	48
223-1d15e2.60A5Z40	15	2.60	5	40	223-1d20e0.80A5Z40	20	0.80	5	40

**Z**  
**24-160**





**λ**  
**0°**

**γ**  
**8°**

**MG6**

**N**

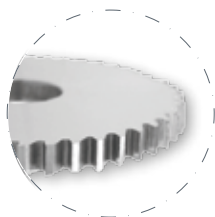
## Slitting saw DIN 1837 fine pitch



Available  
uncoated or coated  
(see page 61)

**Z**  
24-160



**λ**  
0°

**γ**  
8°

**MG6** **N**

Art. n°	d <sub>1</sub>	e	d <sub>2</sub>	Z	Art. n°	d <sub>1</sub>	e	d <sub>2</sub>	Z
223-1d20e0.90A5Z40	20	0.90	5	40	223-1d25e0.60A8Z64	25	0.60	8	64
223-1d20e1.00A5Z40	20	1.00	5	40	223-1d25e0.70A8Z48	25	0.70	8	48
223-1d20e1.10A5Z40	20	1.10	5	40	223-1d25e0.80A8Z48	25	0.80	8	48
223-1d20e1.20A5Z40	20	1.20	5	40	223-1d25e0.90A8Z48	25	0.90	8	48
223-1d20e1.30A5Z40	20	1.30	5	40	223-1d25e1.00A8Z48	25	1.00	8	48
223-1d20e1.40A5Z40	20	1.40	5	40	223-1d25e1.10A8Z48	25	1.10	8	48
223-1d20e1.50A5Z40	20	1.50	5	40	223-1d25e1.20A8Z48	25	1.20	8	48
223-1d20e1.60A5Z40	20	1.60	5	40	223-1d25e1.30A8Z40	25	1.30	8	40
223-1d20e1.70A5Z32	20	1.70	5	32	223-1d25e1.40A8Z40	25	1.40	8	40
223-1d20e1.80A5Z32	20	1.80	5	32	223-1d25e1.50A8Z40	25	1.50	8	40
223-1d20e1.90A5Z32	20	1.90	5	32	223-1d25e1.60A8Z40	25	1.60	8	40
223-1d20e2.00A5Z32	20	2.00	5	32	223-1d25e1.70A8Z40	25	1.70	8	40
223-1d20e2.10A5Z32	20	2.10	5	32	223-1d25e1.80A8Z40	25	1.80	8	40
223-1d20e2.20A5Z32	20	2.20	5	32	223-1d25e1.90A8Z40	25	1.90	8	40
223-1d20e2.30A5Z32	20	2.30	5	32	223-1d25e2.00A8Z40	25	2.00	8	40
223-1d20e2.40A5Z32	20	2.40	5	32	223-1d25e2.10A8Z40	25	2.10	8	40
223-1d20e2.50A5Z32	20	2.50	5	32	223-1d25e2.20A8Z40	25	2.20	8	40
223-1d20e2.60A5Z32	20	2.60	5	32	223-1d25e2.30A8Z40	25	2.30	8	40
223-1d20e2.70A5Z32	20	2.70	5	32	223-1d25e2.40A8Z40	25	2.40	8	40
223-1d20e2.80A5Z32	20	2.80	5	32	223-1d25e2.50A8Z40	25	2.50	8	40
223-1d20e2.90A5Z32	20	2.90	5	32	223-1d25e2.60A8Z32	25	2.60	8	32
223-1d20e3.00A5Z32	20	3.00	5	32	223-1d25e2.70A8Z32	25	2.70	8	32
223-1d20e3.10A5Z24	20	3.10	5	24	223-1d25e2.80A8Z32	25	2.80	8	32
223-1d20e3.20A5Z24	20	3.20	5	24	223-1d25e2.90A8Z32	25	2.90	8	32
223-1d20e3.30A5Z24	20	3.30	5	24	223-1d25e3.00A8Z32	25	3.00	8	32
223-1d20e3.40A5Z24	20	3.40	5	24	223-1d25e3.10A8Z32	25	3.10	8	32
223-1d20e3.50A5Z24	20	3.50	5	24	223-1d25e3.20A8Z32	25	3.20	8	32
223-1d20e3.60A5Z24	20	3.60	5	24	223-1d25e3.30A8Z32	25	3.30	8	32
223-1d20e3.70A5Z24	20	3.70	5	24	223-1d25e3.40A8Z32	25	3.40	8	32
223-1d20e3.80A5Z24	20	3.80	5	24	223-1d25e3.50A8Z32	25	3.50	8	32
223-1d20e3.90A5Z24	20	3.90	5	24	223-1d25e3.60A8Z32	25	3.60	8	32
223-1d20e4.00A5Z24	20	4.00	5	24	223-1d25e3.70A8Z32	25	3.70	8	32
223-1d20e4.50A5Z24	20	4.50	5	24	223-1d25e3.80A8Z32	25	3.80	8	32
223-1d20e5.00A5Z24	20	5.00	5	24	223-1d25e3.90A8Z32	25	3.90	8	32
223-1d20e5.50A5Z24	20	5.50	5	24	223-1d25e4.00A8Z32	25	4.00	8	32
223-1d20e6.00A5Z24	20	6.00	5	24	223-1d25e4.50A8Z32	25	4.50	8	32
223-1d25e0.10A8Z80	25	0.10	8	80	223-1d25e5.00A8Z32	25	5.00	8	32
223-1d25e0.15A8Z80	25	0.15	8	80	223-1d25e5.50A8Z24	25	5.50	8	24
223-1d25e0.20A8Z80	25	0.20	8	80	223-1d25e6.00A8Z24	25	6.00	8	24
223-1d25e0.25A8Z80	25	0.25	8	80	--> Ref. 223-2	30	0.10	8	100
223-1d25e0.30A8Z80	25	0.30	8	80	--> Ref. 223-2	30	0.15	8	100
223-1d25e0.35A8Z64	25	0.35	8	64	--> Ref. 223-2	30	0.20	8	100
223-1d25e0.40A8Z64	25	0.40	8	64	--> Ref. 223-2	30	0.25	8	100
223-1d25e0.45A8Z64	25	0.45	8	64	223-1d30e0.30A8Z80	30	0.30	8	80
223-1d25e0.50A8Z64	25	0.50	8	64	223-1d30e0.35A8Z80	30	0.35	8	80



# Slitting saw DIN 1837 fine pitch

## 223-1

Continuation

Art. n°	d <sub>1</sub>	e	d <sub>2</sub>	Z	Art. n°	d <sub>1</sub>	e	d <sub>2</sub>	Z
223-1d30e0.40A8Z80	30	0.40	8	80	--> Ref. 223-2	40	0.25	10	100
223-1d30e0.45A8Z80	30	0.45	8	80	--> Ref. 223-2	40	0.30	10	100
223-1d30e0.50A8Z80	30	0.50	8	80	--> Ref. 223-2	40	0.35	10	100
223-1d30e0.60A8Z64	30	0.60	8	64	--> Ref. 223-2	40	0.40	10	100
223-1d30e0.70A8Z64	30	0.70	8	64	223-1d40e0.45A10Z80	40	0.45	10	80
223-1d30e0.80A8Z64	30	0.80	8	64	223-1d40e0.50A10Z80	40	0.50	10	80
223-1d30e0.90A8Z64	30	0.90	8	64	223-1d40e0.60A10Z80	40	0.60	10	80
223-1d30e1.00A8Z64	30	1.00	8	64	223-1d40e0.70A10Z80	40	0.70	10	80
223-1d30e1.10A8Z48	30	1.10	8	48	223-1d40e0.80A10Z80	40	0.80	10	80
223-1d30e1.20A8Z48	30	1.20	8	48	223-1d40e0.90A10Z64	40	0.90	10	64
223-1d30e1.30A8Z48	30	1.30	8	48	223-1d40e1.00A10Z64	40	1.00	10	64
223-1d30e1.40A8Z48	30	1.40	8	48	223-1d40e1.10A10Z64	40	1.10	10	64
223-1d30e1.50A8Z48	30	1.50	8	48	223-1d40e1.20A10Z64	40	1.20	10	64
223-1d30e1.60A8Z48	30	1.60	8	48	223-1d40e1.30A10Z64	40	1.30	10	64
223-1d30e1.70A8Z48	30	1.70	8	48	223-1d40e1.40A10Z64	40	1.40	10	64
223-1d30e1.80A8Z48	30	1.80	8	48	223-1d40e1.50A10Z64	40	1.50	10	64
223-1d30e1.90A8Z48	30	1.90	8	48	223-1d40e1.60A10Z64	40	1.60	10	64
223-1d30e2.00A8Z48	30	2.00	8	48	223-1d40e1.70A10Z48	40	1.70	10	48
223-1d30e2.10A8Z40	30	2.10	8	40	223-1d40e1.80A10Z48	40	1.80	10	48
223-1d30e2.20A8Z40	30	2.20	8	40	223-1d40e1.90A10Z48	40	1.90	10	48
223-1d30e2.30A8Z40	30	2.30	8	40	223-1d40e2.00A10Z48	40	2.00	10	48
223-1d30e2.40A8Z40	30	2.40	8	40	223-1d40e2.10A10Z48	40	2.10	10	48
223-1d30e2.50A8Z40	30	2.50	8	40	223-1d40e2.20A10Z48	40	2.20	10	48
223-1d30e2.60A8Z40	30	2.60	8	40	223-1d40e2.30A10Z48	40	2.30	10	48
223-1d30e2.70A8Z40	30	2.70	8	40	223-1d40e2.40A10Z48	40	2.40	10	48
223-1d30e2.80A8Z40	30	2.80	8	40	223-1d40e2.50A10Z48	40	2.50	10	48
223-1d30e2.90A8Z40	30	2.90	8	40	223-1d40e2.60A10Z48	40	2.60	10	48
223-1d30e3.00A8Z40	30	3.00	8	40	223-1d40e2.70A10Z48	40	2.70	10	48
223-1d30e3.10A8Z40	30	3.10	8	40	223-1d40e2.80A10Z48	40	2.80	10	48
223-1d30e3.20A8Z40	30	3.20	8	40	223-1d40e2.90A10Z48	40	2.90	10	48
223-1d30e3.30A8Z40	30	3.30	8	40	223-1d40e3.00A10Z48	40	3.00	10	48
223-1d30e3.40A8Z40	30	3.40	8	40	223-1d40e3.10A10Z40	40	3.10	10	40
223-1d30e3.50A8Z40	30	3.50	8	40	223-1d40e3.20A10Z40	40	3.20	10	40
223-1d30e3.60A8Z40	30	3.60	8	40	223-1d40e3.30A10Z40	40	3.30	10	40
223-1d30e3.70A8Z40	30	3.70	8	40	223-1d40e3.40A10Z40	40	3.40	10	40
223-1d30e3.80A8Z40	30	3.80	8	40	223-1d40e3.50A10Z40	40	3.50	10	40
223-1d30e3.90A8Z40	30	3.90	8	40	223-1d40e3.60A10Z40	40	3.60	10	40
223-1d30e4.00A8Z40	30	4.00	8	40	223-1d40e3.70A10Z40	40	3.70	10	40
223-1d30e4.50A8Z32	30	4.50	8	32	223-1d40e3.80A10Z40	40	3.80	10	40
223-1d30e5.00A8Z32	30	5.00	8	32	223-1d40e3.90A10Z40	40	3.90	10	40
223-1d30e5.50A8Z32	30	5.50	8	32	223-1d40e4.00A10Z40	40	4.00	10	40
223-1d30e6.00A8Z32	30	6.00	8	32	223-1d40e4.50A10Z40	40	4.50	10	40
223-1d40e0.10A10Z128	40	0.10	10	128	223-1d40e5.00A10Z40	40	5.00	10	40
223-1d40e0.15A10Z128	40	0.15	10	128	223-1d40e5.50A10Z40	40	5.50	10	40
223-1d40e0.20A10Z128	40	0.20	10	128	223-1d40e6.00A10Z40	40	6.00	10	40

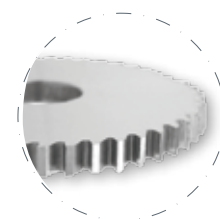

Available uncoated or coated (see page 61)



Z  
24-160



λ  
0°

γ  
8°

MG6

N

## Slitting saw DIN 1837 fine pitch



Available uncoated or coated (see page 61)

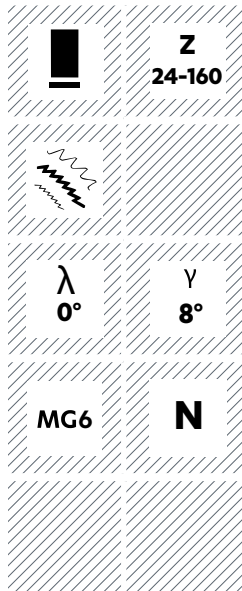

Art. n°	d <sub>1</sub>	e	d <sub>2</sub>	Z	Art. n°	d <sub>1</sub>	e	d <sub>2</sub>	Z
223-1d50e0.20A13Z128	50	0.20	13	128	223-1d50e6.00A13Z40	50	6.00	13	40
223-1d50e0.25A13Z128	50	0.25	13	128	223-1d63e0.20A16Z160	63	0.20	16	160
223-1d50e0.30A13Z128	50	0.30	13	128	223-1d63e0.25A16Z128	63	0.25	16	128
223-1d50e0.35A13Z100	50	0.35	13	100	223-1d63e0.30A16Z128	63	0.30	16	128
223-1d50e0.40A13Z100	50	0.40	13	100	223-1d63e0.35A16Z128	63	0.35	16	128
223-1d50e0.45A13Z100	50	0.45	13	100	223-1d63e0.40A16Z128	63	0.40	16	128
223-1d50e0.50A13Z100	50	0.50	13	100	223-1d63e0.45A16Z128	63	0.45	16	128
223-1d50e0.60A13Z100	50	0.60	13	100	223-1d63e0.50A16Z128	63	0.50	16	128
223-1d50e0.70A13Z80	50	0.70	13	80	223-1d63e0.60A16Z100	63	0.60	16	100
223-1d50e0.80A13Z80	50	0.80	13	80	223-1d63e0.70A16Z100	63	0.70	16	100
223-1d50e0.90A13Z80	50	0.90	13	80	223-1d63e0.80A16Z100	63	0.80	16	100
223-1d50e1.00A13Z80	50	1.00	13	80	223-1d63e0.90A16Z100	63	0.90	16	100
223-1d50e1.10A13Z80	50	1.10	13	80	223-1d63e1.00A16Z100	63	1.00	16	100
223-1d50e1.20A13Z80	50	1.20	13	80	223-1d63e1.10A16Z80	63	1.10	16	80
223-1d50e1.30A13Z64	50	1.30	13	64	223-1d63e1.20A16Z80	63	1.20	16	80
223-1d50e1.40A13Z64	50	1.40	13	64	223-1d63e1.30A16Z80	63	1.30	16	80
223-1d50e1.50A13Z64	50	1.50	13	64	223-1d63e1.40A16Z80	63	1.40	16	80
223-1d50e1.60A13Z64	50	1.60	13	64	223-1d63e1.50A16Z80	63	1.50	16	80
223-1d50e1.70A13Z64	50	1.70	13	64	223-1d63e1.60A16Z80	63	1.60	16	80
223-1d50e1.80A13Z64	50	1.80	13	64	223-1d63e1.70A16Z80	63	1.70	16	80
223-1d50e1.90A13Z64	50	1.90	13	64	223-1d63e1.80A16Z80	63	1.80	16	80
223-1d50e2.00A13Z64	50	2.00	13	64	223-1d63e1.90A16Z80	63	1.90	16	80
223-1d50e2.10A13Z64	50	2.10	13	64	223-1d63e2.00A16Z80	63	2.00	16	80
223-1d50e2.20A13Z64	50	2.20	13	64	223-1d63e2.10A16Z64	63	2.10	16	64
223-1d50e2.30A13Z64	50	2.30	13	64	223-1d63e2.20A16Z64	63	2.20	16	64
223-1d50e2.40A13Z64	50	2.40	13	64	223-1d63e2.30A16Z64	63	2.30	16	64
223-1d50e2.50A13Z64	50	2.50	13	64	223-1d63e2.40A16Z64	63	2.40	16	64
223-1d50e2.60A13Z48	50	2.60	13	48	223-1d63e2.50A16Z64	63	2.50	16	64
223-1d50e2.70A13Z48	50	2.70	13	48	223-1d63e2.60A16Z64	63	2.60	16	64
223-1d50e2.80A13Z48	50	2.80	13	48	223-1d63e2.70A16Z64	63	2.70	16	64
223-1d50e2.90A13Z48	50	2.90	13	48	223-1d63e2.80A16Z64	63	2.80	16	64
223-1d50e3.00A13Z48	50	3.00	13	48	223-1d63e2.90A16Z64	63	2.90	16	64
223-1d50e3.10A13Z48	50	3.10	13	48	223-1d63e3.00A16Z64	63	3.00	16	64
223-1d50e3.20A13Z48	50	3.20	13	48	223-1d63e3.10A16Z64	63	3.10	16	64
223-1d50e3.30A13Z48	50	3.30	13	48	223-1d63e3.20A16Z64	63	3.20	16	64
223-1d50e3.40A13Z48	50	3.40	13	48	223-1d63e3.30A16Z64	63	3.30	16	64
223-1d50e3.50A13Z48	50	3.50	13	48	223-1d63e3.40A16Z64	63	3.40	16	64
223-1d50e3.60A13Z48	50	3.60	13	48	223-1d63e3.50A16Z64	63	3.50	16	64
223-1d50e3.70A13Z48	50	3.70	13	48	223-1d63e3.60A16Z64	63	3.60	16	64
223-1d50e3.80A13Z48	50	3.80	13	48	223-1d63e3.70A16Z64	63	3.70	16	64
223-1d50e3.90A13Z48	50	3.90	13	48	223-1d63e3.80A16Z64	63	3.80	16	64
223-1d50e4.00A13Z48	50	4.00	13	48	223-1d63e3.90A16Z64	63	3.90	16	64
223-1d50e4.50A13Z48	50	4.50	13	48	223-1d63e4.00A16Z64	63	4.00	16	64
223-1d50e5.00A13Z48	50	5.00	13	48	223-1d63e4.50A16Z48	63	4.50	16	48
223-1d50e5.50A13Z40	50	5.50	13	40	223-1d63e5.00A16Z48	63	5.00	16	48



# Slitting saw DIN 1837 fine pitch

**223-1**

Continuation

Art. n°	d <sub>1</sub>	e	d <sub>2</sub>	Z	Art. n°	d <sub>1</sub>	e	d <sub>2</sub>	Z
223-1d63e5.50A16Z48	63	5.50	16	48	223-1d80e5.50A22Z64	80	5.50	22	64
223-1d63e6.00A16Z48	63	6.00	16	48	223-1d80e6.00A22Z64	80	6.00	22	64
223-1d80e0.25A22Z160	80	0.25	22	160	223-1d100e0.50A22Z160	100	0.50	22	160
223-1d80e0.30A22Z160	80	0.30	22	160	223-1d100e0.60A22Z160	100	0.60	22	160
223-1d80e0.35A22Z160	80	0.35	22	160	223-1d100e0.70A22Z128	100	0.70	22	128
223-1d80e0.40A22Z160	80	0.40	22	160	223-1d100e0.80A22Z128	100	0.80	22	128
223-1d80e0.45A22Z128	80	0.45	22	128	223-1d100e0.90A22Z128	100	0.90	22	128
223-1d80e0.50A22Z128	80	0.50	22	128	223-1d100e1.00A22Z128	100	1.00	22	128
223-1d80e0.60A22Z128	80	0.60	22	128	223-1d100e1.10A22Z128	100	1.10	22	128
223-1d80e0.70A22Z128	80	0.70	22	128	223-1d100e1.20A22Z128	100	1.20	22	128
223-1d80e0.80A22Z128	80	0.80	22	128	223-1d100e1.30A22Z100	100	1.30	22	100
223-1d80e0.90A22Z100	80	0.90	22	100	223-1d100e1.40A22Z100	100	1.40	22	100
223-1d80e1.00A22Z100	80	1.00	22	100	223-1d100e1.50A22Z100	100	1.50	22	100
223-1d80e1.10A22Z100	80	1.10	22	100	223-1d100e1.60A22Z100	100	1.60	22	100
223-1d80e1.20A22Z100	80	1.20	22	100	223-1d100e1.70A22Z100	100	1.70	22	100
223-1d80e1.30A22Z100	80	1.30	22	100	223-1d100e1.80A22Z100	100	1.80	22	100
223-1d80e1.40A22Z100	80	1.40	22	100	223-1d100e1.90A22Z100	100	1.90	22	100
223-1d80e1.50A22Z100	80	1.50	22	100	223-1d100e2.00A22Z100	100	2.00	22	100
223-1d80e1.60A22Z100	80	1.60	22	100	223-1d100e2.10A22Z100	100	2.10	22	100
223-1d80e1.70A22Z80	80	1.70	22	80	223-1d100e2.20A22Z100	100	2.20	22	100
223-1d80e1.80A22Z80	80	1.80	22	80	223-1d100e2.30A22Z100	100	2.30	22	100
223-1d80e1.90A22Z80	80	1.90	22	80	223-1d100e2.40A22Z100	100	2.40	22	100
223-1d80e2.00A22Z80	80	2.00	22	80	223-1d100e2.50A22Z100	100	2.50	22	100
223-1d80e2.10A22Z80	80	2.10	22	80	223-1d100e2.60A22Z80	100	2.60	22	80
223-1d80e2.20A22Z80	80	2.20	22	80	223-1d100e2.70A22Z80	100	2.70	22	80
223-1d80e2.30A22Z80	80	2.30	22	80	223-1d100e2.80A22Z80	100	2.80	22	80
223-1d80e2.40A22Z80	80	2.40	22	80	223-1d100e2.90A22Z80	100	2.90	22	80
223-1d80e2.50A22Z80	80	2.50	22	80	223-1d100e3.00A22Z80	100	3.00	22	80
223-1d80e2.60A22Z80	80	2.60	22	80	223-1d100e3.10A22Z80	100	3.10	22	80
223-1d80e2.70A22Z80	80	2.70	22	80	223-1d100e3.20A22Z80	100	3.20	22	80
223-1d80e2.80A22Z80	80	2.80	22	80	223-1d100e3.30A22Z80	100	3.30	22	80
223-1d80e2.90A22Z80	80	2.90	22	80	223-1d100e3.40A22Z80	100	3.40	22	80
223-1d80e3.00A22Z80	80	3.00	22	80	223-1d100e3.50A22Z80	100	3.50	22	80
223-1d80e3.10A22Z64	80	3.10	22	64	223-1d100e3.60A22Z80	100	3.60	22	80
223-1d80e3.20A22Z64	80	3.20	22	64	223-1d100e3.70A22Z80	100	3.70	22	80
223-1d80e3.30A22Z64	80	3.30	22	64	223-1d100e3.80A22Z80	100	3.80	22	80
223-1d80e3.40A22Z64	80	3.40	22	64	223-1d100e3.90A22Z80	100	3.90	22	80
223-1d80e3.50A22Z64	80	3.50	22	64	223-1d100e4.00A22Z80	100	4.00	22	80
223-1d80e3.60A22Z64	80	3.60	22	64	223-1d100e4.50A22Z80	100	4.50	22	80
223-1d80e3.70A22Z64	80	3.70	22	64	223-1d100e5.00A22Z80	100	5.00	22	80
223-1d80e3.80A22Z64	80	3.80	22	64	223-1d100e5.50A22Z64	100	5.50	22	64
223-1d80e3.90A22Z64	80	3.90	22	64	223-1d100e6.00A22Z64	100	6.00	22	64
223-1d80e4.00A22Z64	80	4.00	22	64	223-1d125e0.60A22Z160	125	0.60	22	160
223-1d80e4.50A22Z64	80	4.50	22	64	223-1d125e0.70A22Z160	125	0.70	22	160
223-1d80e5.00A22Z64	80	5.00	22	64	223-1d125e0.80A22Z160	125	0.80	22	160



Available uncoated or coated (see page 61)



Z  
24-160



λ  
0°

γ  
8°

MG6

N

## Slitting saw DIN 1837 fine pitch



Available  
uncoated or coated  
(see page 61)

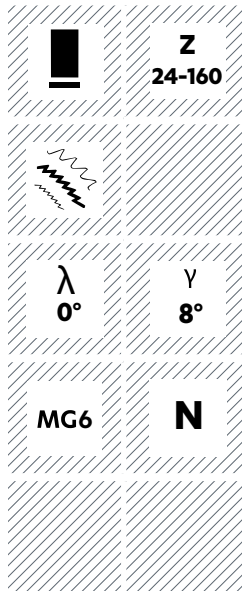

Art. n°	d <sub>1</sub>	e	d <sub>2</sub>	Z
223-1d125e0.90A22Z160	125	0.90	22	160
223-1d125e1.00A22Z160	125	1.00	22	160
223-1d125e1.10A22Z128	125	1.10	22	128
223-1d125e1.20A22Z128	125	1.20	22	128
223-1d125e1.30A22Z128	125	1.30	22	128
223-1d125e1.40A22Z128	125	1.40	22	128
223-1d125e1.50A22Z128	125	1.50	22	128
223-1d125e1.60A22Z128	125	1.60	22	128
223-1d125e1.70A22Z128	125	1.70	22	128
223-1d125e1.80A22Z128	125	1.80	22	128
223-1d125e1.90A22Z128	125	1.90	22	128
223-1d125e2.00A22Z128	125	2.00	22	128
223-1d125e2.10A22Z100	125	2.10	22	100
223-1d125e2.20A22Z100	125	2.20	22	100
223-1d125e2.30A22Z100	125	2.30	22	100
223-1d125e2.40A22Z100	125	2.40	22	100
223-1d125e2.50A22Z100	125	2.50	22	100
223-1d125e2.60A22Z100	125	2.60	22	100
223-1d125e2.70A22Z100	125	2.70	22	100
223-1d125e2.80A22Z100	125	2.80	22	100
223-1d125e2.90A22Z100	125	2.90	22	100
223-1d125e3.00A22Z100	125	3.00	22	100
223-1d125e3.10A22Z100	125	3.10	22	100
223-1d125e3.20A22Z100	125	3.20	22	100
223-1d125e3.30A22Z100	125	3.30	22	100
223-1d125e3.40A22Z100	125	3.40	22	100
223-1d125e3.50A22Z100	125	3.50	22	100
223-1d125e3.60A22Z100	125	3.60	22	100
223-1d125e3.70A22Z100	125	3.70	22	100
223-1d125e3.80A22Z100	125	3.80	22	100
223-1d125e3.90A22Z100	125	3.90	22	100
223-1d125e4.00A22Z100	125	4.00	22	100
223-1d125e4.50A22Z100	125	4.50	22	100
223-1d125e5.00A22Z100	125	5.00	22	100
223-1d125e5.50A22Z100	125	5.50	22	100
223-1d125e6.00A22Z100	125	6.00	22	100
223-1d160e1.00A32Z160	160	1.00	32	160
223-1d160e1.20A32Z160	160	1.20	32	160
223-1d160e1.50A32Z160	160	1.50	32	160
223-1d160e1.60A32Z160	160	1.60	32	160
223-1d160e1.80A32Z128	160	1.80	32	128
223-1d160e2.00A32Z128	160	2.00	32	128
223-1d160e2.50A32Z128	160	2.50	32	128
223-1d160e3.00A32Z128	160	3.00	32	128



# Slitting saw extra fine pitch

223-2

Material	Vc uncoated	Vc coated	Uncoated	Coated	Rec. Coating
Steel < 700 N/mm <sup>2</sup>	80	120	☐	■	Trio
Steel > 700 N/mm <sup>2</sup>	60	100	☐	■	Trio
Stainless steel	60	100	☐	■	Trio
Cast iron	50	90	☐	■	Nemo
Copper	200	300	☐	■	Solo
Brass - Bronze	200	300	☐	■	Solo
Aluminium	250	400	☐	■	Solo
Gold - Silver	150	300	■	-	Solo
Platinum - Palladium	-	-	-	-	-
Superalloys	20	40	☐	■	Trio
Titanium	40	60	☐	■	Rico

not adapted - adapted ☐ highly adapted ■

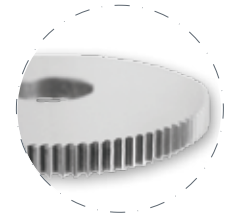
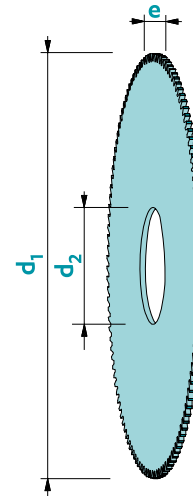

Tolerance e: +/-0.01  
d<sub>2</sub>: H5

Available uncoated or coated (see page 61)

Art. n°	d <sub>1</sub>	e	d <sub>2</sub>	Z	Art. n°	d <sub>1</sub>	e	d <sub>2</sub>	Z
223-2d8e0.10A3Z48	8	0.10	3	48	223-2d12e0.30A5Z64	12	0.30	5	64
223-2d8e0.15A3Z48	8	0.15	3	48	223-2d12e0.35A5Z64	12	0.35	5	64
223-2d8e0.20A3Z48	8	0.20	3	48	223-2d12e0.40A5Z64	12	0.40	5	64
223-2d8e0.25A3Z48	8	0.25	3	48	223-2d12e0.50A5Z64	12	0.50	5	64
223-2d8e0.30A3Z48	8	0.30	3	48	223-2d12e0.60A5Z64	12	0.60	5	64
223-2d8e0.35A3Z48	8	0.35	3	48	223-2d12e0.70A5Z64	12	0.70	5	64
223-2d8e0.40A3Z48	8	0.40	3	48	223-2d12e0.80A5Z64	12	0.80	5	64
223-2d8e0.50A3Z48	8	0.50	3	48	223-2d12e0.90A5Z64	12	0.90	5	64
223-2d8e0.60A3Z48	8	0.60	3	48	223-2d15e0.10A5Z80	15	0.10	5	80
223-2d8e0.70A3Z48	8	0.70	3	48	223-2d15e0.15A5Z80	15	0.15	5	80
223-2d8e0.80A3Z48	8	0.80	3	48	223-2d15e0.20A5Z80	15	0.20	5	80
223-2d8e0.90A3Z48	8	0.90	3	48	223-2d15e0.25A5Z80	15	0.25	5	80
223-2d8e1.00A3Z48	8	1.00	3	48	223-2d15e0.30A5Z80	15	0.30	5	80
223-2d10e0.10A3Z64	10	0.10	3	64	223-2d15e0.35A5Z80	15	0.35	5	80
223-2d10e0.15A3Z64	10	0.15	3	64	223-2d15e0.40A5Z80	15	0.40	5	80
223-2d10e0.20A3Z64	10	0.20	3	64	223-2d15e0.50A5Z80	15	0.50	5	80
223-2d10e0.25A3Z64	10	0.25	3	64	223-2d15e0.60A5Z80	15	0.60	5	80
223-2d10e0.30A3Z64	10	0.30	3	64	223-2d15e0.70A5Z80	15	0.70	5	80
223-2d10e0.35A3Z64	10	0.35	3	64	223-2d15e0.80A5Z80	15	0.80	5	80
223-2d10e0.40A3Z64	10	0.40	3	64	223-2d15e0.90A5Z80	15	0.90	5	80
223-2d10e0.50A3Z64	10	0.50	3	64	223-2d15e1.00A5Z80	15	1.00	5	80
223-2d10e0.60A3Z64	10	0.60	3	64	223-2d15e1.10A5Z80	15	1.10	5	80
223-2d10e0.70A3Z64	10	0.70	3	64	223-2d15e1.20A5Z80	15	1.20	5	80
223-2d10e0.80A3Z64	10	0.80	3	64	223-2d15e1.30A5Z80	15	1.30	5	80
223-2d10e0.90A3Z64	10	0.90	3	64	223-2d15e1.40A5Z80	15	1.40	5	80
223-2d10e1.00A3Z64	10	1.00	3	64	223-2d15e1.50A5Z80	15	1.50	5	80
223-2d12e0.10A5Z64	12	0.10	5	64	223-2d15e2.00A5Z80	15	2.00	5	80
223-2d12e0.15A5Z64	12	0.15	5	64	223-2d15e2.50A5Z80	15	2.50	5	80
223-2d12e0.20A5Z64	12	0.20	5	64	223-2d15e3.00A5Z80	15	3.00	5	80
223-2d12e0.25A5Z64	12	0.25	5	64					

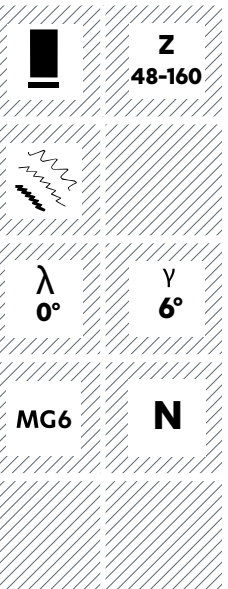

## Slitting saw extra fine pitch

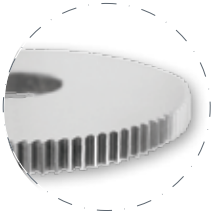

Available uncoated or coated (see page 61)



Z  
48-160



$\lambda$   
0°

$\gamma$   
6°

MG6

N

Art. n°	d <sub>1</sub>	e	d <sub>2</sub>	Z	Art. n°	d <sub>1</sub>	e	d <sub>2</sub>	Z
223-2d20e0.10A5Z100	20	0.10	5	100	223-2d20e3.00A5Z80	20	3.00	5	80
223-2d20e0.10A6Z80	20	0.10	6	80	223-2d20e3.00A6Z80	20	3.00	6	80
223-2d20e0.15A5Z100	20	0.15	5	100	223-2d25e0.10A5Z80	25	0.10	5	80
223-2d20e0.15A6Z80	20	0.15	6	80	223-2d25e0.15A5Z80	25	0.15	5	80
223-2d20e0.20A5Z100	20	0.20	5	100	223-2d25e0.15A6Z100	25	0.15	6	100
223-2d20e0.20A6Z80	20	0.20	6	80	223-2d25e0.15A8Z100	25	0.15	8	100
223-2d20e0.25A5Z80	20	0.25	5	80	223-2d25e0.20A5Z80	25	0.20	5	80
223-2d20e0.25A5Z100	20	0.25	5	100	223-2d25e0.20A6Z100	25	0.20	6	100
223-2d20e0.25A6Z80	20	0.25	6	80	223-2d25e0.20A8Z100	25	0.20	8	100
223-2d20e0.30A5Z80	20	0.30	5	80	223-2d25e0.25A5Z80	25	0.25	5	80
223-2d20e0.30A5Z100	20	0.30	5	100	223-2d25e0.25A6Z100	25	0.25	6	100
223-2d20e0.30A6Z80	20	0.30	6	80	223-2d25e0.25A8Z100	25	0.25	8	100
223-2d20e0.35A5Z80	20	0.35	5	80	223-2d25e0.30A5Z80	25	0.30	5	80
223-2d20e0.35A5Z100	20	0.35	5	100	223-2d25e0.30A6Z100	25	0.30	6	100
223-2d20e0.35A6Z80	20	0.35	6	80	223-2d25e0.30A8Z100	25	0.30	8	100
223-2d20e0.40A5Z80	20	0.40	5	80	223-2d25e0.35A5Z80	25	0.35	5	80
223-2d20e0.40A5Z100	20	0.40	5	100	223-2d25e0.35A6Z100	25	0.35	6	100
223-2d20e0.40A6Z80	20	0.40	6	80	223-2d25e0.35A8Z100	25	0.35	8	100
223-2d20e0.50A5Z80	20	0.50	5	80	223-2d25e0.40A5Z80	25	0.40	5	80
223-2d20e0.50A5Z100	20	0.50	5	100	223-2d25e0.40A6Z100	25	0.40	6	100
223-2d20e0.50A6Z80	20	0.50	6	80	223-2d25e0.40A8Z100	25	0.40	8	100
223-2d20e0.60A5Z80	20	0.60	5	80	223-2d25e0.50A5Z80	25	0.50	5	80
223-2d20e0.60A6Z80	20	0.60	6	80	223-2d25e0.50A6Z100	25	0.50	6	100
223-2d20e0.70A5Z80	20	0.70	5	80	223-2d25e0.50A8Z100	25	0.50	8	100
223-2d20e0.70A6Z80	20	0.70	6	80	223-2d25e0.60A5Z80	25	0.60	5	80
223-2d20e0.80A5Z80	20	0.80	5	80	223-2d25e0.60A6Z100	25	0.60	6	100
223-2d20e0.80A6Z80	20	0.80	6	80	223-2d25e0.60A8Z100	25	0.60	8	100
223-2d20e0.90A5Z80	20	0.90	5	80	223-2d25e0.70A5Z80	25	0.70	5	80
223-2d20e0.90A6Z80	20	0.90	6	80	223-2d25e0.70A6Z100	25	0.70	6	100
223-2d20e1.00A5Z80	20	1.00	5	80	223-2d25e0.70A8Z100	25	0.70	8	100
223-2d20e1.00A6Z80	20	1.00	6	80	223-2d25e0.80A5Z80	25	0.80	5	80
223-2d20e1.10A5Z80	20	1.10	5	80	223-2d25e0.80A6Z100	25	0.80	6	100
223-2d20e1.10A6Z80	20	1.10	6	80	223-2d25e0.80A8Z100	25	0.80	8	100
223-2d20e1.20A5Z80	20	1.20	5	80	223-2d25e0.90A5Z80	25	0.90	5	80
223-2d20e1.20A6Z80	20	1.20	6	80	223-2d25e0.90A6Z100	25	0.90	6	100
223-2d20e1.30A5Z80	20	1.30	5	80	223-2d25e0.90A8Z100	25	0.90	8	100
223-2d20e1.30A6Z80	20	1.30	6	80	223-2d25e1.00A5Z80	25	1.00	5	80
223-2d20e1.40A5Z80	20	1.40	5	80	223-2d25e1.00A6Z100	25	1.00	6	100
223-2d20e1.40A6Z80	20	1.40	6	80	223-2d25e1.00A8Z100	25	1.00	8	100
223-2d20e1.50A5Z80	20	1.50	5	80	223-2d25e1.10A5Z80	25	1.10	5	80
223-2d20e1.50A6Z80	20	1.50	6	80	223-2d25e1.10A6Z100	25	1.10	6	100
223-2d20e2.00A5Z80	20	2.00	5	80	223-2d25e1.10A8Z100	25	1.10	8	100
223-2d20e2.00A6Z80	20	2.00	6	80	223-2d25e1.20A5Z80	25	1.20	5	80
223-2d20e2.50A5Z80	20	2.50	5	80	223-2d25e1.20A6Z100	25	1.20	6	100
223-2d20e2.50A6Z80	20	2.50	6	80	223-2d25e1.20A8Z100	25	1.20	8	100



# Slitting saw extra fine pitch

**223-2**

Continuation

Art. n°	d <sub>1</sub>	e	d <sub>2</sub>	Z	Art. n°	d <sub>1</sub>	e	d <sub>2</sub>	Z
223-2d25e1.30A5Z80	25	1.30	5	80	223-2d32e0.50A8Z80	32	0.50	8	80
223-2d25e1.30A6Z100	25	1.30	6	100	223-2d32e0.60A8Z80	32	0.60	8	80
223-2d25e1.30A8Z100	25	1.30	8	100	223-2d32e0.70A8Z80	32	0.70	8	80
223-2d25e1.40A5Z80	25	1.40	5	80	223-2d32e0.80A8Z80	32	0.80	8	80
223-2d25e1.40A6Z100	25	1.40	6	100	223-2d32e0.90A8Z80	32	0.90	8	80
223-2d25e1.40A8Z100	25	1.40	8	100	223-2d32e1.00A8Z80	32	1.00	8	80
223-2d25e1.50A5Z80	25	1.50	5	80	223-2d32e1.10A8Z80	32	1.10	8	80
223-2d25e1.50A6Z100	25	1.50	6	100	223-2d32e1.20A8Z80	32	1.20	8	80
223-2d25e1.50A8Z100	25	1.50	8	100	223-2d32e1.30A8Z80	32	1.30	8	80
223-2d25e2.00A5Z80	25	2.00	5	80	223-2d32e1.40A8Z80	32	1.40	8	80
223-2d25e2.00A6Z100	25	2.00	6	100	223-2d32e1.50A8Z80	32	1.50	8	80
223-2d25e2.00A8Z100	25	2.00	8	100	223-2d32e2.00A8Z80	32	2.00	8	80
223-2d25e2.50A5Z80	25	2.50	5	80	223-2d32e2.50A8Z80	32	2.50	8	80
223-2d25e2.50A6Z100	25	2.50	6	100	223-2d32e3.00A8Z80	32	3.00	8	80
223-2d25e2.50A8Z100	25	2.50	8	100	223-2d35e0.15A8Z96	35	0.15	8	96
223-2d25e3.00A5Z80	25	3.00	5	80	223-2d35e0.20A8Z96	35	0.20	8	96
223-2d25e3.00A6Z100	25	3.00	6	100	223-2d35e0.25A8Z96	35	0.25	8	96
223-2d25e3.00A8Z100	25	3.00	8	100	223-2d35e0.30A8Z96	35	0.30	8	96
223-2d30e0.10A8Z100	30	0.10	8	100	223-2d35e0.35A8Z96	35	0.35	8	96
223-2d30e0.15A8Z100	30	0.15	8	100	223-2d35e0.40A8Z96	35	0.40	8	96
223-2d30e0.20A8Z100	30	0.20	8	100	223-2d35e0.50A8Z96	35	0.50	8	96
223-2d30e0.25A8Z100	30	0.25	8	100	223-2d35e0.60A8Z96	35	0.60	8	96
223-2d30e0.30A8Z100	30	0.30	8	100	223-2d35e0.70A8Z96	35	0.70	8	96
223-2d30e0.35A8Z100	30	0.35	8	100	223-2d35e0.80A8Z96	35	0.80	8	96
223-2d30e0.40A8Z100	30	0.40	8	100	223-2d35e0.90A8Z96	35	0.90	8	96
223-2d30e0.50A8Z100	30	0.50	8	100	223-2d35e1.00A8Z96	35	1.00	8	96
223-2d30e0.60A8Z100	30	0.60	8	100	223-2d35e1.10A8Z96	35	1.10	8	96
223-2d30e0.70A8Z100	30	0.70	8	100	223-2d35e1.20A8Z96	35	1.20	8	96
223-2d30e0.80A8Z100	30	0.80	8	100	223-2d35e1.30A8Z96	35	1.30	8	96
223-2d30e0.90A8Z100	30	0.90	8	100	223-2d35e1.40A8Z96	35	1.40	8	96
223-2d30e1.00A8Z100	30	1.00	8	100	223-2d35e1.50A8Z96	35	1.50	8	96
223-2d30e1.10A8Z100	30	1.10	8	100	223-2d35e2.00A8Z96	35	2.00	8	96
223-2d30e1.20A8Z100	30	1.20	8	100	223-2d35e2.50A8Z96	35	2.50	8	96
223-2d30e1.30A8Z100	30	1.30	8	100	223-2d35e3.00A8Z96	35	3.00	8	96
223-2d30e1.40A8Z100	30	1.40	8	100	223-2d40e0.15A8Z100	40	0.15	8	100
223-2d30e1.50A8Z100	30	1.50	8	100	223-2d40e0.15A8Z160	40	0.15	8	160
223-2d30e2.00A8Z100	30	2.00	8	100	223-2d40e0.15A10Z100	40	0.15	10	100
223-2d30e2.50A8Z100	30	2.50	8	100	223-2d40e0.15A10Z160	40	0.15	10	160
223-2d30e3.00A8Z100	30	3.00	8	100	223-2d40e0.20A8Z100	40	0.20	8	100
223-2d32e0.15A8Z80	32	0.15	8	80	223-2d40e0.20A8Z160	40	0.20	8	160
223-2d32e0.20A8Z80	32	0.20	8	80	223-2d40e0.20A10Z100	40	0.20	10	100
223-2d32e0.25A8Z80	32	0.25	8	80	223-2d40e0.20A10Z160	40	0.20	10	160
223-2d32e0.30A8Z80	32	0.30	8	80	223-2d40e0.25A8Z100	40	0.25	8	100
223-2d32e0.35A8Z80	32	0.35	8	80	223-2d40e0.25A8Z160	40	0.25	8	160
223-2d32e0.40A8Z80	32	0.40	8	80	223-2d40e0.25A10Z100	40	0.25	10	100

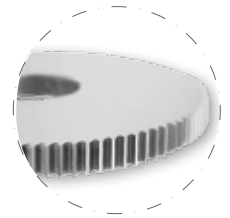

Available  
uncoated or coated  
(see page 61)



Z  
48-160



λ  
0°

γ  
6°

MG6

N

## Slitting saw extra fine pitch

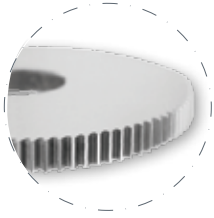

Available  
uncoated or coated  
(see page 61)

**Z**  
48-160



**λ**  
0°

**γ**  
6°

**MG6**      **N**

Art. n°	d <sub>1</sub>	e	d <sub>2</sub>	Z	Art. n°	d <sub>1</sub>	e	d <sub>2</sub>	Z
223-2d40e0.25A10Z160	40	0.25	10	160	223-2d40e1.30A8Z100	40	1.30	8	100
223-2d40e0.30A8Z100	40	0.30	8	100	223-2d40e1.30A8Z160	40	1.30	8	160
223-2d40e0.30A8Z160	40	0.30	8	160	223-2d40e1.30A10Z100	40	1.30	10	100
223-2d40e0.30A10Z100	40	0.30	10	100	223-2d40e1.30A10Z160	40	1.30	10	160
223-2d40e0.30A10Z160	40	0.30	10	160	223-2d40e1.40A8Z100	40	1.40	8	100
223-2d40e0.35A8Z100	40	0.35	8	100	223-2d40e1.40A8Z160	40	1.40	8	160
223-2d40e0.35A8Z160	40	0.35	8	160	223-2d40e1.40A10Z100	40	1.40	10	100
223-2d40e0.35A10Z100	40	0.35	10	100	223-2d40e1.40A10Z160	40	1.40	10	160
223-2d40e0.35A10Z160	40	0.35	10	160	223-2d40e1.50A8Z100	40	1.50	8	100
223-2d40e0.40A8Z100	40	0.40	8	100	223-2d40e1.50A8Z160	40	1.50	8	160
223-2d40e0.40A8Z160	40	0.40	8	160	223-2d40e1.50A10Z100	40	1.50	10	100
223-2d40e0.40A10Z100	40	0.40	10	100	223-2d40e1.50A10Z160	40	1.50	10	160
223-2d40e0.40A10Z160	40	0.40	10	160	223-2d40e2.00A8Z100	40	2.00	8	100
223-2d40e0.50A8Z100	40	0.50	8	100	223-2d40e2.00A8Z160	40	2.00	8	160
223-2d40e0.50A8Z160	40	0.50	8	160	223-2d40e2.00A10Z100	40	2.00	10	100
223-2d40e0.50A10Z100	40	0.50	10	100	223-2d40e2.00A10Z160	40	2.00	10	160
223-2d40e0.50A10Z160	40	0.50	10	160	223-2d40e2.50A8Z100	40	2.50	8	100
223-2d40e0.60A8Z100	40	0.60	8	100	223-2d40e2.50A8Z160	40	2.50	8	160
223-2d40e0.60A8Z160	40	0.60	8	160	223-2d40e2.50A10Z100	40	2.50	10	100
223-2d40e0.60A10Z100	40	0.60	10	100	223-2d40e2.50A10Z160	40	2.50	10	160
223-2d40e0.60A10Z160	40	0.60	10	160	223-2d40e3.00A8Z100	40	3.00	8	100
223-2d40e0.70A8Z100	40	0.70	8	100	223-2d40e3.00A8Z160	40	3.00	8	160
223-2d40e0.70A8Z160	40	0.70	8	160	223-2d40e3.00A10Z100	40	3.00	10	100
223-2d40e0.70A10Z100	40	0.70	10	100	223-2d40e3.00A10Z160	40	3.00	10	160
223-2d40e0.70A10Z160	40	0.70	10	160	223-2d45e0.15A8Z100	45	0.15	8	100
223-2d40e0.80A8Z100	40	0.80	8	100	223-2d45e0.15A8Z160	45	0.15	8	160
223-2d40e0.80A8Z160	40	0.80	8	160	223-2d45e0.20A8Z100	45	0.20	8	100
223-2d40e0.80A10Z100	40	0.80	10	100	223-2d45e0.20A8Z160	45	0.20	8	160
223-2d40e0.80A10Z160	40	0.80	10	160	223-2d45e0.25A8Z100	45	0.25	8	100
223-2d40e0.90A8Z100	40	0.90	8	100	223-2d45e0.25A8Z160	45	0.25	8	160
223-2d40e0.90A8Z160	40	0.90	8	160	223-2d45e0.30A8Z100	45	0.30	8	100
223-2d40e0.90A10Z100	40	0.90	10	100	223-2d45e0.30A8Z160	45	0.30	8	160
223-2d40e0.90A10Z160	40	0.90	10	160	223-2d45e0.35A8Z100	45	0.35	8	100
223-2d40e1.00A8Z100	40	1.00	8	100	223-2d45e0.35A8Z160	45	0.35	8	160
223-2d40e1.00A8Z160	40	1.00	8	160	223-2d45e0.40A8Z100	45	0.40	8	100
223-2d40e1.00A10Z100	40	1.00	10	100	223-2d45e0.40A8Z160	45	0.40	8	160
223-2d40e1.00A10Z160	40	1.00	10	160	223-2d45e0.50A8Z100	45	0.50	8	100
223-2d40e1.10A8Z100	40	1.10	8	100	223-2d45e0.50A8Z160	45	0.50	8	160
223-2d40e1.10A8Z160	40	1.10	8	160	223-2d45e0.60A8Z100	45	0.60	8	100
223-2d40e1.10A10Z100	40	1.10	10	100	223-2d45e0.60A8Z160	45	0.60	8	160
223-2d40e1.10A10Z160	40	1.10	10	160	223-2d45e0.70A8Z100	45	0.70	8	100
223-2d40e1.20A8Z100	40	1.20	8	100	223-2d45e0.70A8Z160	45	0.70	8	160
223-2d40e1.20A8Z160	40	1.20	8	160	223-2d45e0.80A8Z100	45	0.80	8	100
223-2d40e1.20A10Z100	40	1.20	10	100	223-2d45e0.80A8Z160	45	0.80	8	160
223-2d40e1.20A10Z160	40	1.20	10	160	223-2d45e0.90A8Z100	45	0.90	8	100

